

Article number: 201226030

Description: E+G Magnets with bore GN 50.4-HF-32-7-5,5
Hard ferrite - 200° C, 72N

Measures

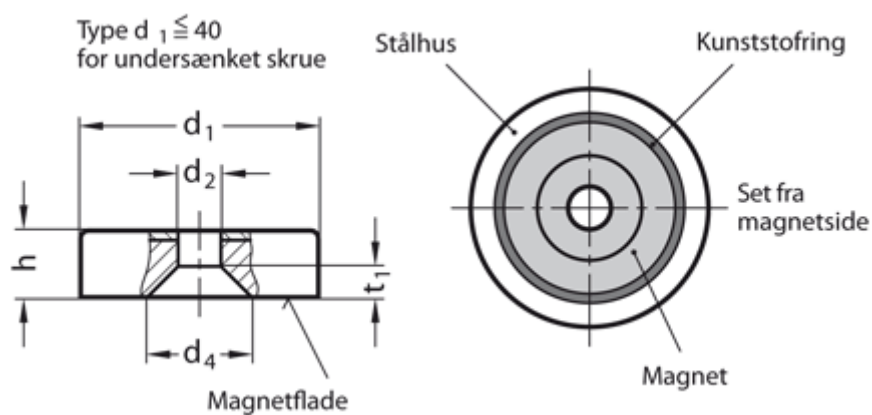

d_1 = $32 \pm 0,1$

d_2 = 5.5

d_4 = 11.5

h = $7 + 0,3/-0,1$

Holding force N = 72

Material = HF hard ferrite - 200°.C

t = 3.0